

Parts List, Installation and General Information

BL2615MG

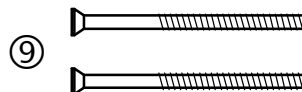
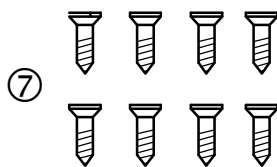
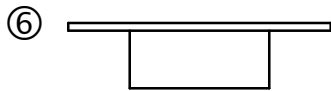
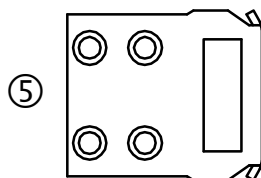
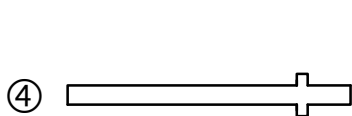
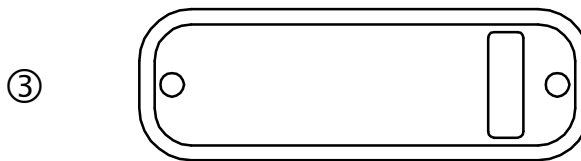
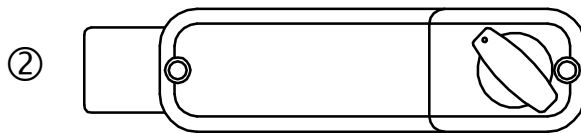
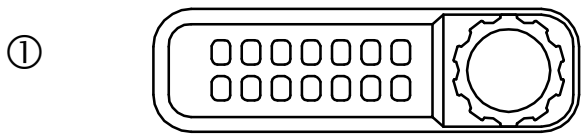

PARTS LIST

Please make sure you have received all the following parts:

- (1) Keypad
- (2) Inside lock body
- (3) Neoprene seals x 2
- (4) Spindles
- (5) Surface lock keep
- (6) Morticed lock keep
- (7) Wood screws x 8
- (8) Tweezers (For changing the code)
- (9) Fixing bolts 5 supplied
- (10) Spare tumblers. 2 x Coded
2 x Uncoded
- (11) Code card
- (12) Hexagonal shaft x 2

SPECIAL NOTES

Before commencing installation check that all parts are working correctly: Press the code according to the code card and then the knob should turn and return easily under spring pressure. If you intend to change the code, you should do it before installing the lock, See the code change instructions.

CHECK THE HAND OF YOUR DOOR

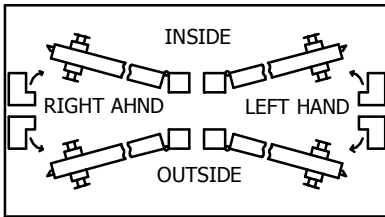

Your door is right-handed, if viewed, from the outside the hinges are on the right.

CHANGING THE HANDING OF THE UNIT

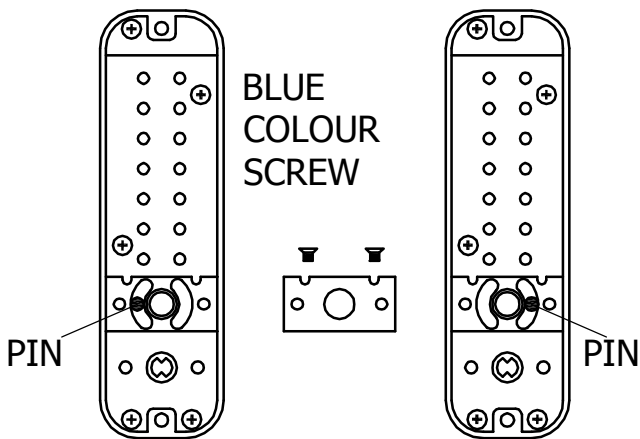

FOR RIGHT HAND DOOR

FOR LEFT HAND DOOR



HOW TO CHANGE YOUR CODE NUMBER

- 1) Remove the lock from the door .
- 2) Remove the 2 retaining screws from the back of the keypad. Take EXTRA care to keep the keypad on a flat surface, when you are removing the covering plate, because there are a lot of small components inside.
- 3) You will now see that there are 5 red coloured coded tumblers & 8 blue coloured uncoded tumblers plus 1 clear tumbler ('C' button).
- 4) To change your code, push the 'C' button down and hold it. You can then easily remove one or more of your coded & uncoded tumblers, using the tweezers supplied.
Remember, the red tumblers represent coded digits and the blue tumblers represent non-coded digits
- 5) Please note you should NEVER remove the 'C' tumbler.
- 6) Please note the different shapes of tumblers, before reinserting them into the lock body. Firstly there is a difference in shape between the coded & uncoded tumblers, illustrated below. And secondly when refitting the tumblers into the lock body, they must be fitted facing the right way, again see the illustration Below. (All square cutouts must face outwards)
- 7) After you have refitted the tumblers and made a note of the new code, please replace the metal plate with the 2 screws
- 8) PLEASE NOTE. With the spare tumblers provided, you can either increase the number of digits in your code to 6 - 7 or reduce to 3 - 4.

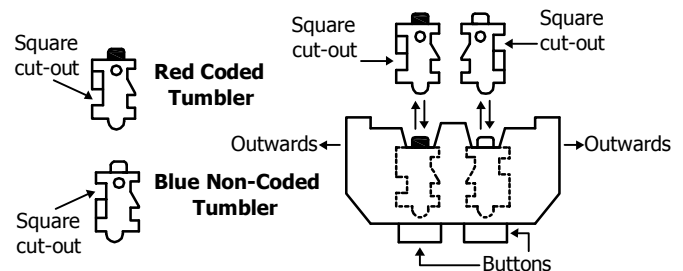

If you experience any problems when fitting this lock or changing the code please contact the:

BORG HELPLINE

00800 44 88 377

Dismantling the lock will invalidate your warranty

Assembling and Fitting

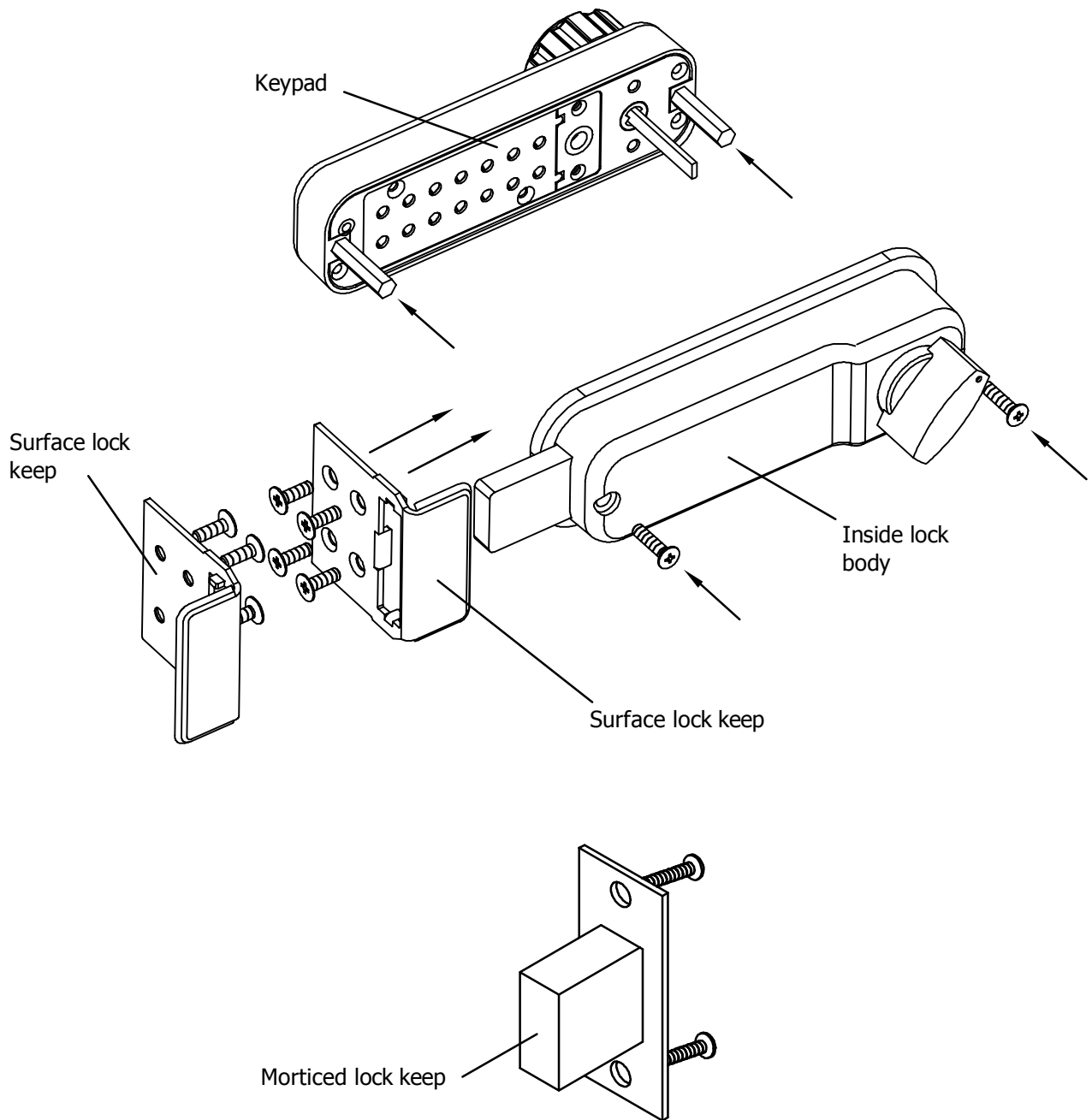

MAINTENANCE INSTRUCTIONS

WEEKLY

CLEAN THE SURFACE OF THE LOCK WITH MARINE GRADE CHROME POLISHING LIQUID. SPRAY THE EXPOSED PARTS OF THE LATCH WITH WD40 OR EQUIVALENT.

ANNUALLY

1. REMOVE THE LOCK FROM THE DOOR.
2. SPRAY THE INSIDE OF THE LOCK THOROUGHLY WITH WD40 OR EQUIVALENT, THROUGH THE TUMBLER HOLES AT THE BACK OF THE LOCK.
3. SPRAY ALL THE FIXING ACCESSORIES AND THE LATCH WITH WD40 OR EQUIVALENT.
4. PUSH EACH OF THE BUTTONS AND ROTATE THE KNOB SEVERAL TIMES TO MAKE SURE THE LOCK IS WORKING SMOOTHLY.

REMARKS

THE ABOVE MAINTENANCE PROCEDURES CAN BE CARRIED OUT WHENEVER THE OPERATION OF THE LOCK IS STICKY.